

Compact. Flexible. Productive.

TCU-Z Tolerance Compensation Unit

The TCU is compensated on the basis of elastomers that compensate in all three directions, enabling them to correct angle errors and to carry out rotational compensation. Pneumatic locking is also available as an option to allow the compensation unit to be set to rigid. As a result, it is possible to prevent the tool or the gripper vibrating during movement of the robot arm. PZN-plus grippers and grippers with the same screw connection pattern on the base side can be mounted on the unit without adaptation.

Field of Application

For universal use in clean and slightly dirty environments, with special requirements for the corrosion resistance and antistatic properties of the gripper unit



Advantages – Your benefit

Compensation of workpiece-related tolerances and position inaccuracies reduced risk of jamming, necessary assembly forces are reduced and wear of the workpiece and handling device is minimized

Direct assembly of parallel grippers no need for additional adapter plates

Compact design minimized height and weight

Pneumatic locking long life span of the elastomers, rigid unit during travel

Monitoring of locking for process reliable sequences and shorter cycle times



Sizes
Quantity: 7



Workpiece weight
3 .. 60 kg



Deflection
1°

Functional Description

The TCU's function is based on the interaction between the two base plates, which are connected to each other by a set of flexible elastomer elements. As a result, the TCU can compensate tolerances in the X-, Y-, and Z-directions, allowing it to correct angle errors and provide rotational compensation. Pneumatic locking is also available as an option to allow the compensation unit to be set to rigid.

As a result, it is possible to prevent the tool or the gripper vibrating during movement of the robot arm or the linear axis. This increases the application's repeat accuracy and extends the service life of the elastomer elements. Direct assembly of the appropriate gripper types without additional adapter plates enables a flat and weight-reduced compensation system.

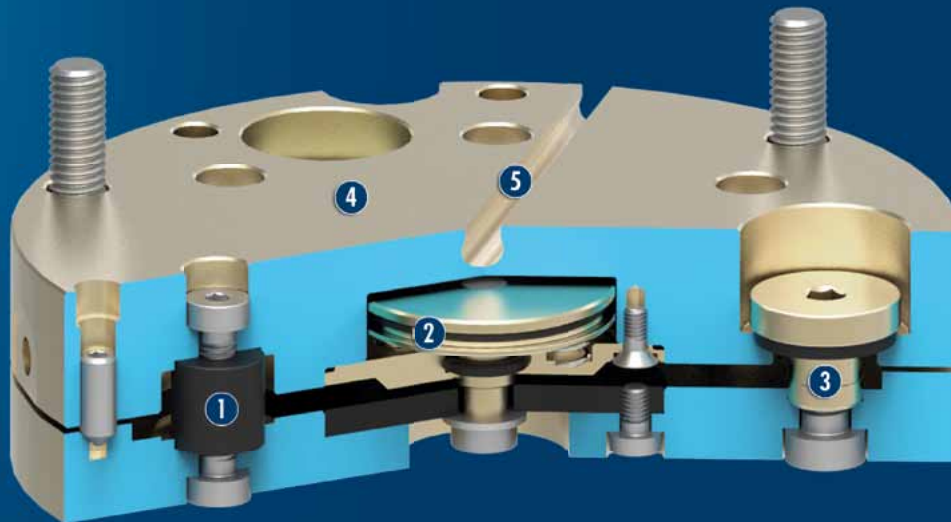

- ① **Elastomers**
allow compensation motion
- ② **Locking mechanism**
for a rigid connection between the machine and tool sides
- ③ **Overload pin**
to protect the elastomers
- ④ **Interface machine side**
the same mounting pattern as on the tool side
- ⑤ **Monitoring groove**
for electronic magnetic sensor

CAD data, operating manuals and other current product documents are available at www.schunk.com

General Notes to the Series

Monitoring: by magnetic switch

Actuation: pneumatic, with filtered compressed air as per DIN ISO 8573-1: 7 4 4

Material: Elastomer material

Housing: Aluminum alloy

Scope of delivery: Robot-side mounting screws

Warranty: 24 months (details, general terms and conditions and operation manuals can be downloaded at www.schunk.com)

Harsh environmental conditions: Please note that the use in harsh environmental conditions (e.g. in the coolant area, cast and grinding dust) can considerably reduce the service lifetime of the units, and will void warranty. However, in many cases we can find a solution. Please contact us.

Handling weight: The weight of the total load attached to the flange. The design must take into account the permissible forces and moments. Please note that the life span will be reduced if the maximum handling weight is exceeded.

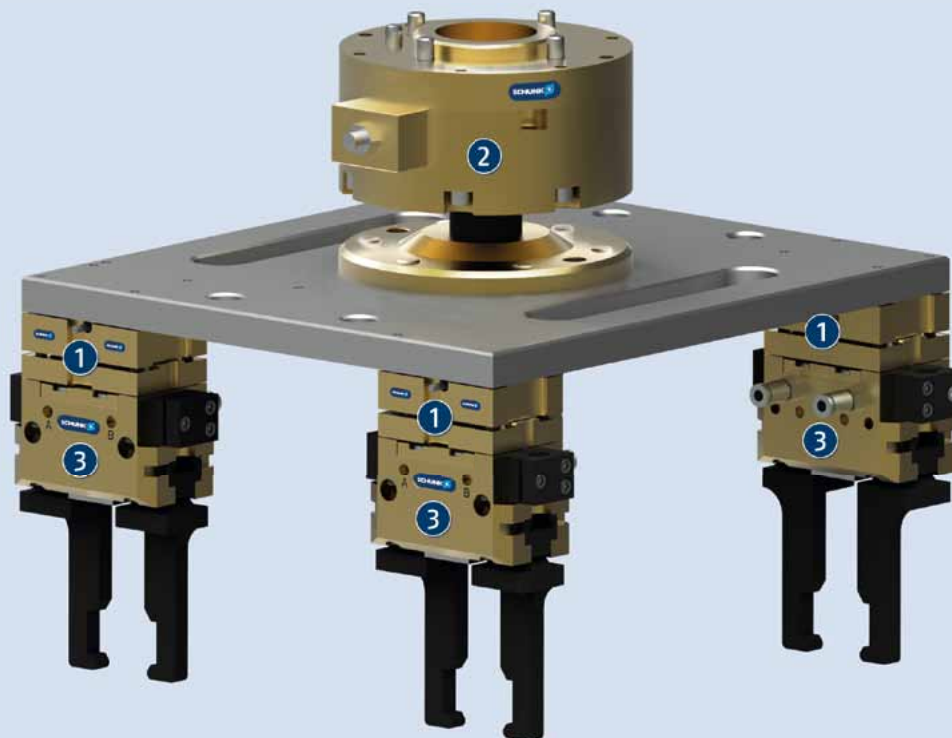

Application example

In applications where several grippers are used, the tolerance variations of the workpieces are compensated by the tolerance compensation units. The

application is also monitored by a collision sensor.

① TCU Tolerance Compensation Unit

② OPS Collision Sensor

③ JGP 2-Finger Parallel Gripper with workpiece-specific gripper fingers

SCHUNK offers more ...

The following components make the TCU-Z even more productive – the perfect complement for highest functionality, flexibility, and process reliability.



Fittings



Magnetic Switches



Sensor Cables



SDV-P Pressure Maintenance Valve



PZN-plus Centric Gripper

① Further information regarding the products can be found on the following products pages or at www.schunk.com. Please contact us for further information: SCHUNK technical hotline +49-7133-103-2696

Options and special Information

Monitoring of the locking: by magnetic switch

Connections: two plug-in connections for hose

Ambient temperature: 5 °C to 90 °C

Operating pressure: from 4 bar to 8 bar

TCU-Z 080

Robot Accessories | Compensating | Tolerance Compensation Unit



Load chart

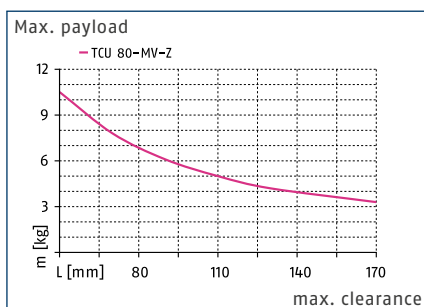

Forces and moments

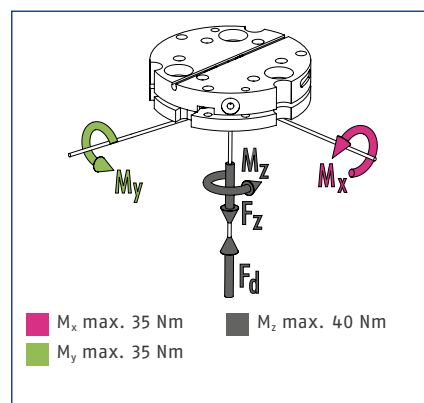

① The forces and torques are maximum values when unlocked and may occur simultaneously. When locked, only the loads caused by the weight and acceleration are permissible.

Technical data

Description		TCU-080-3-MV-Z	TCU-080-3-OV-Z
ID		0324784	0324785
Hardness of the elastomer	[Shore]	68	68
Deflection X	[°]	1	1
Deflection Y	[°]	1	1
Deflection Z	[°]	1	1
Repeat accuracy	[mm]	0.05	
Mass	[kg]	0.25	0.3
min. / max. operating pressure	[bar]	4/8	4/8
Locking device		with locking	without locking
Locking moment M_x	[Nm]	5	
Locking moment M_y	[Nm]	5	
Locking moment M_z	[Nm]	6	
Locking force F_z	[N]	100	
max. force F_d	[N]	1500	1500
Direct connection to*		PZN-plus 80	PZN-plus 80

* and for other gripper with the same mounting pattern

Main view with centric locking (MV)

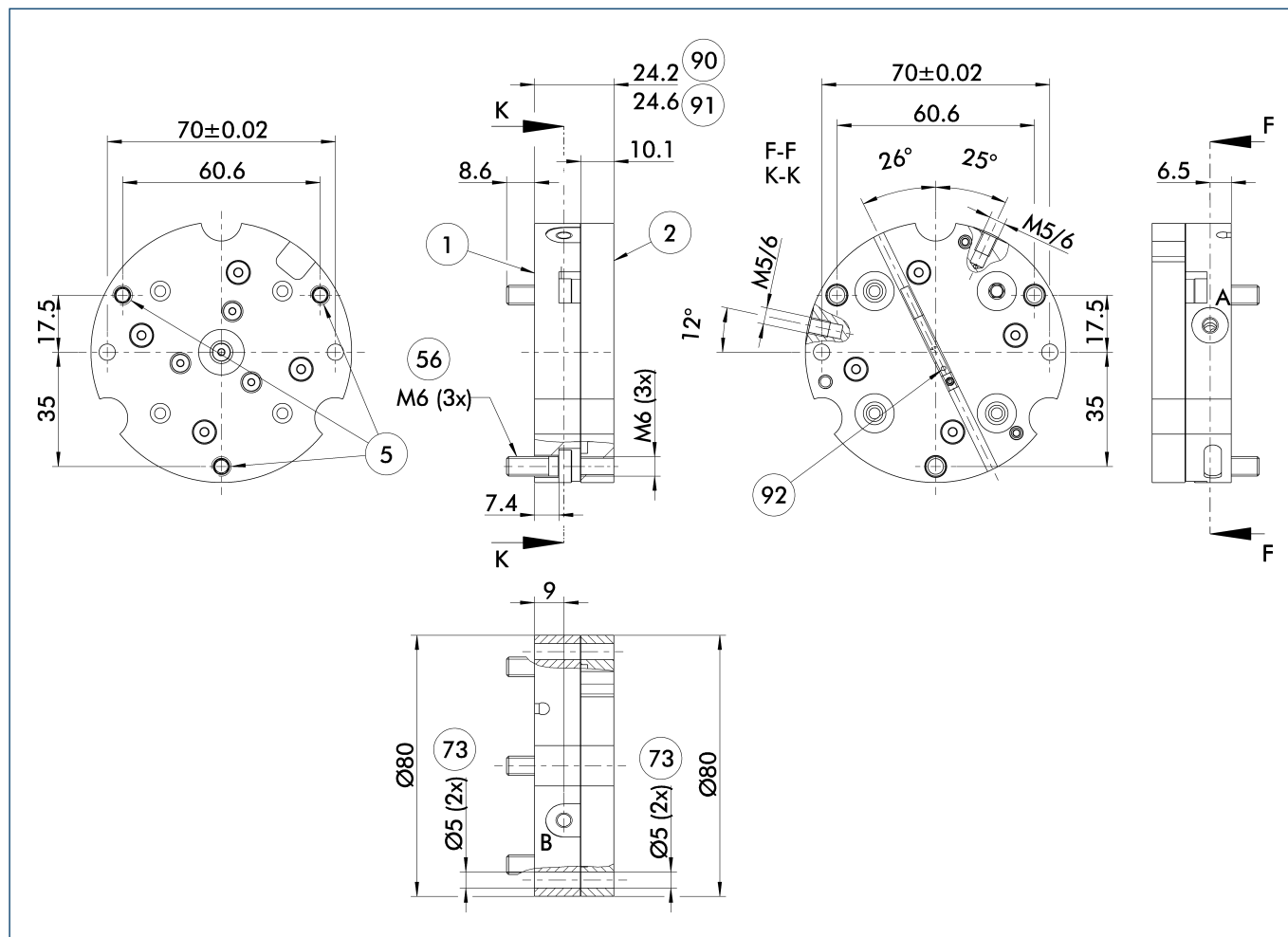

The main view shows the unit in its basic version.

- A, a Air connection locked
- B, b Air connection unlocked
- ① Robot side connection
- ② Tool side connection
- ⑤ Through-hole for connection with screws
- ⑤⑥ Included in delivery
- ⑦③ Fit for a centering pin
- ⑨⑩ Unit locked
- ⑨① Unit unlocked
- ⑨② MMS-P

Maximum deflection

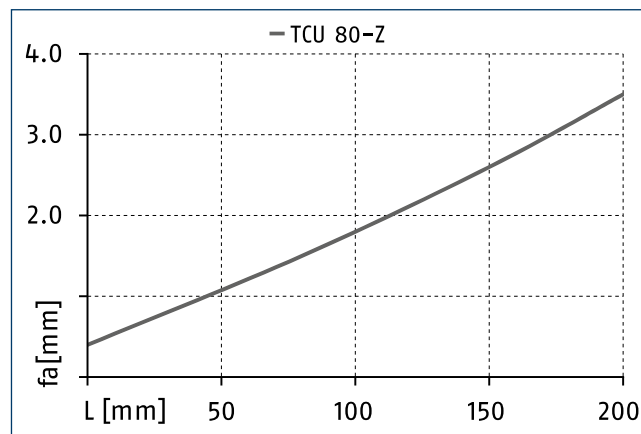
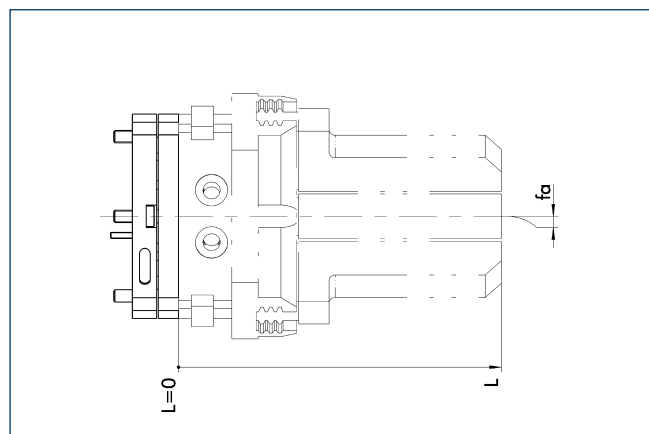

TCU-Z 080

Robot Accessories | Compensating | Tolerance Compensation Unit

Version without locking (0V)

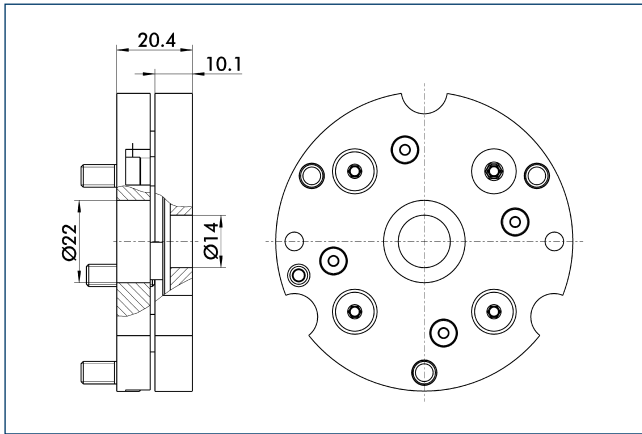

Dimensional changes for the version without locking

Modular system

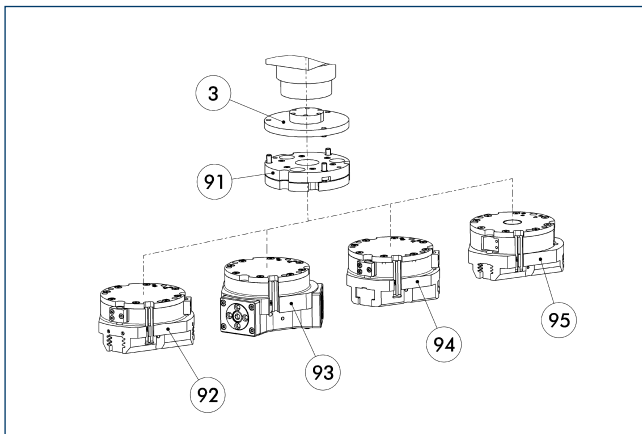

- ③ Adapter plate
- ⑨① TCU tolerance compensation unit
- ⑨② PZN-plus 3-finger centric gripper
- ⑨③ DPZ-plus 3-finger sealed gripper
- ⑨④ JGZ 2-finger centric gripper
- ⑨⑤ PZB-plus 2-finger centric gripper

The unit is part of a modular system in which various components such as grippers or compliant devices can be threaded to one another directly.

Sensor system

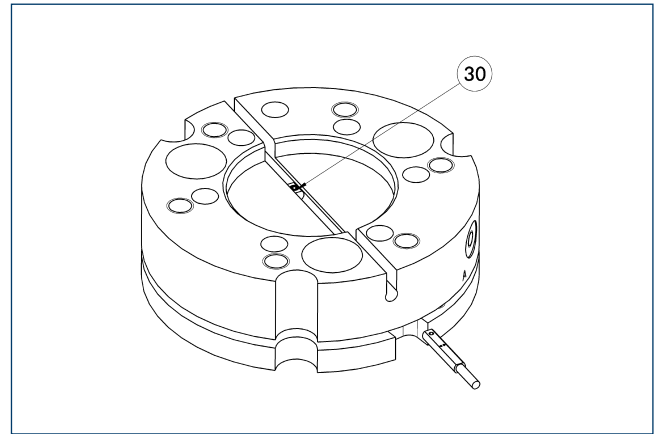

③⑩ Cable connector in the accessory pack with 5 m connection cable

Position monitoring with two programmable positions per sensor. The end position monitoring is mounted in the C-slot.

Description	ID	Often combined
MMS-P programmable magnetic switch		
MMSK-P 22-S-PNP	0301371	
MMS-P 22-S-M8-PNP	0301370	●
Clip		
CLI-M8	0301463	
Connection cables		
KA BG08-L 4P-0500	0307767	●
KA BG08-L 4P-1000	0307768	
KA BW08-L 4P-0500	0307765	
KA BW08-L 4P-1000	0307766	
Sensor distributor		
V2-M8-4P-2XM8-3P	0301380	

① Per unit one sensor (closer/S) is required, optionally a cable extension. Please note the minimum permitted bending radii for the sensor cables, which are generally 35 mm.

