

TENDO E compact CAT 50

- Rundlaufgenauigkeit < 0,003 mm bei 2,5 x D
- Wuchtgüte G2,5 bei 25.000 min⁻¹ oder U_{max} < 1 gmm
- Kurze, schwere Ausführung
- Mit axialer Längenverstellung
- Für automatischen Werkzeugwechsel

TENDO E compact CAT 50

- Run-out accuracy < 0.003 mm at 2.5 x D
- Balancing grade G2.5 at 25,000 RPM or U_{max} < 1 gmm
- Short, rigid design
- With axial length adjustment
- For automatic tool change

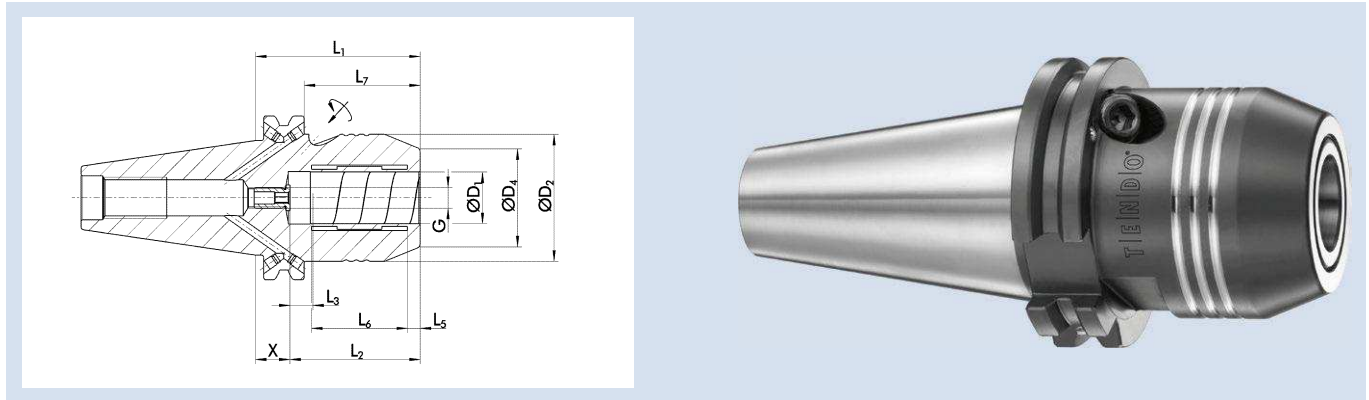











Technische Daten | Technical data

D ₁ [mm]/[inch]	ID		D ₂ [mm]	D ₄ [mm]	X [mm]	L ₁ [mm]	L ₂ [mm]	L ₃ [mm]	L ₅ [mm]	L ₆ [mm]	L ₇ [mm]	G	M _{min} [Nm]	Gewicht Weight [kg]	
32.00	0206498	●	72.00	58.50	20.00	81.00	61.00	10.00	6.00	43.00	61.95	M8x1	900.00	4.10	9205660
1 1/4"	0206478	●	72.00	58.50	20.00	81.00	61.00	10.00	6.00	44.00	61.95	M8x1	900.00	4.10	9205660

Verfügbarkeit: ● lieferbar ab Lager ▲ kurzfristig lieferbar ○ auf Anfrage

Availability: ● available ex stock ▲ short lead time ○ on request

-  Weitere Schaftdurchmesser sind über Zwischenbüchsen spannbar
-  Bohrung für Datenträger optional
-  Werkzeugschaftqualität h6
-  Lieferumfang ohne Betätigungsschlüssel
-  TENDO E compact (E compact = preis-leistungs-optimiert)
Bohrungen für Form AF bei Lieferung mit Gewindestiften verschlossen
Weitere Größen und Sonderausführungen sind auf Anfrage erhältlich

-  Additional shank diameters can be clamped using intermediate sleeves
-  Bore for data carrier as an option
-  Tool shank quality h6
-  Scope of delivery without actuation key
-  TENDO E compact (E compact = excellent cost-performance ratio)
Bores for form AF are sealed with set screws as transport safety
Additional sizes and special designs are available on request

 Zwischenbüchsen
siehe ab Seite 380
Intermediate sleeves
see from page 380

 Büchsenzieher
siehe ab Seite 412
Sleeve remover
see from page 412

 Anzugsbolzen
siehe ab Seite 403
Retention knobs
see from page 403

 Weiteres Zubehör
siehe ab Seite 394
Further accessories
see from page 394